

FEATURES

- TO-18 Hermetic Package
- Low Cost Format
- Low Dark Current
- Low Capacitance

Electro-Optical Characteristics at 25°C

Parameters	Test Conditions	Min	Typ	Max	Units
Active Area	1.35 mm x 0.76 mm		1		mm ²
Responsivity	@ 632 nm	0.36	0.4		A/W
Dark Current, I _{dr}	V _R = 10 V		0.2	1	nA
Reverse Breakdown Voltage, V _R	I _R = 10 A	25	60		Volts
Capacitance, C	V _R = 10 V		0.2	2	pF
Rise Time	V _R = 10 V		8	15	nsec
Series Resistance	V _f = 1 V		25	60	Ohms

Thermal Parameters

Parameters	Units
Storage and Operating Temperature Range	-55°C to 100°C
Maximum Junction Temperature	100°C
Lead Soldering Temperature ¹	260°C

¹ 1/16" from case for 10 seconds.

Capacitance vs Bias Voltage

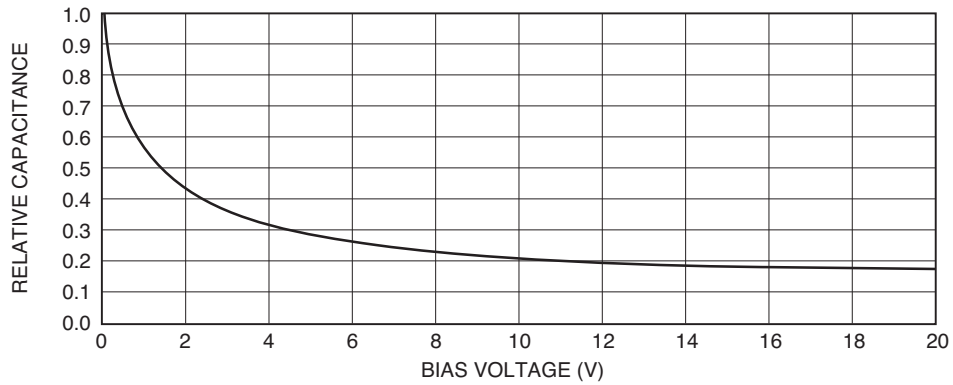

Typical Spectral Response

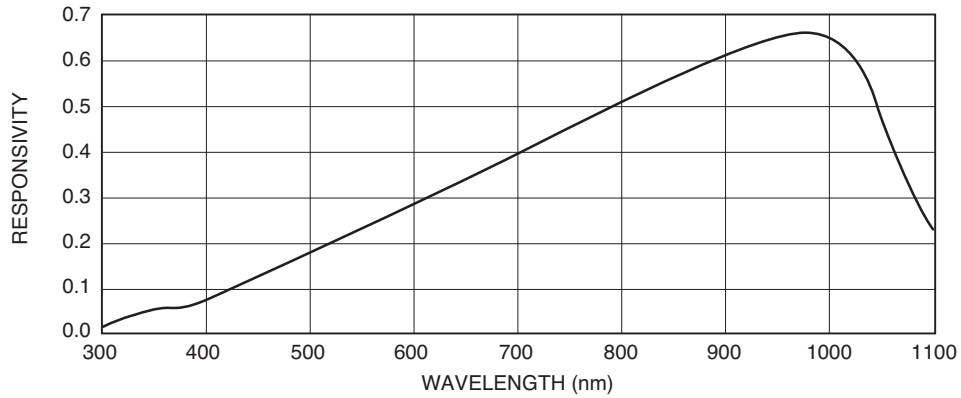

Dark Current vs Voltage

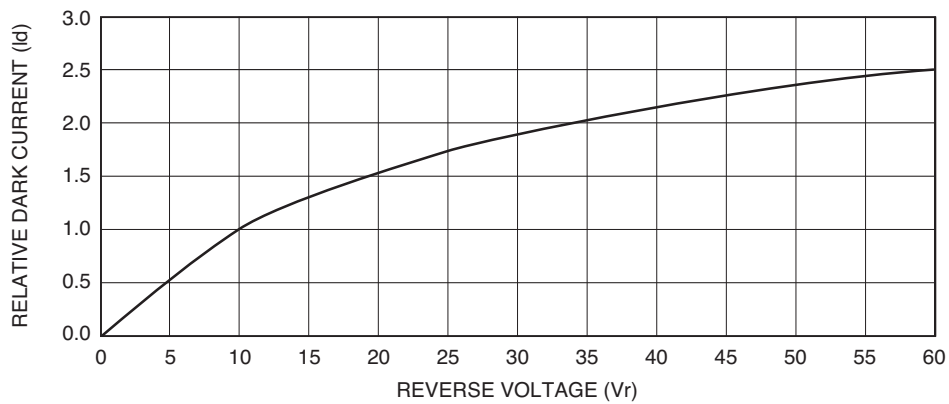

Package Information

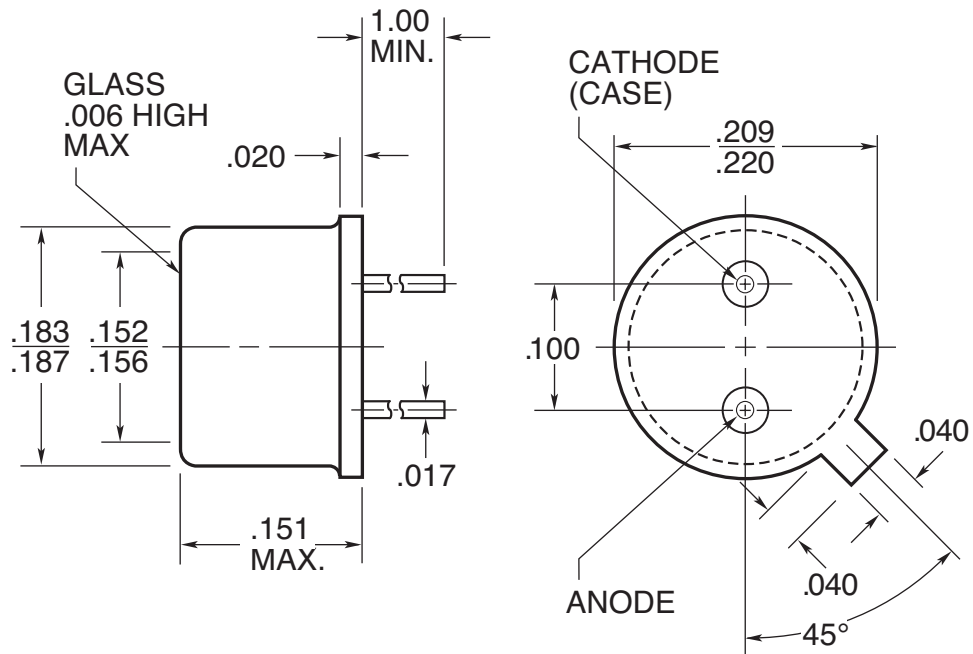

Dimensions are in inch [metric] units.

Specifications are subject to change without prior notice.