

FEATURES

- TO-8 Hermetic Package
- Circular Active Area
- Low Capacitance

Electro-Optical Characteristics at 25°C

Parameters	Test Conditions	Min	Typ	Max	Units
Active Area	4 mm Dia.		12		mm ²
Responsivity	@ 450 nm	0.2	0.28		A/W
Dark Current, I _{dr}	V _R = 10 V		3	7	nA
Reverse Breakdown Voltage, V _R	I _R = 10 μA	25	60		Volts
Capacitance, C	V _R = 10 V		25		pF
Rise Time	V _R = 10 V		15		nsec

Thermal Parameters

Parameters	Units
Storage and Operating Temperature Range	-55°C to 100°C
Maximum Junction Temperature	100°C
Lead Soldering Temperature ¹	260°C

¹ 1/16" from case for 10 seconds.

Capacitance vs. Bias Voltage

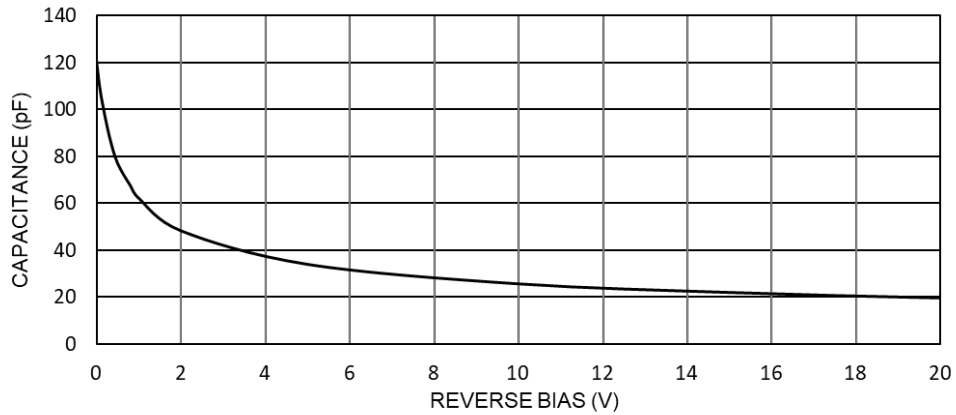

Typical Spectral Response

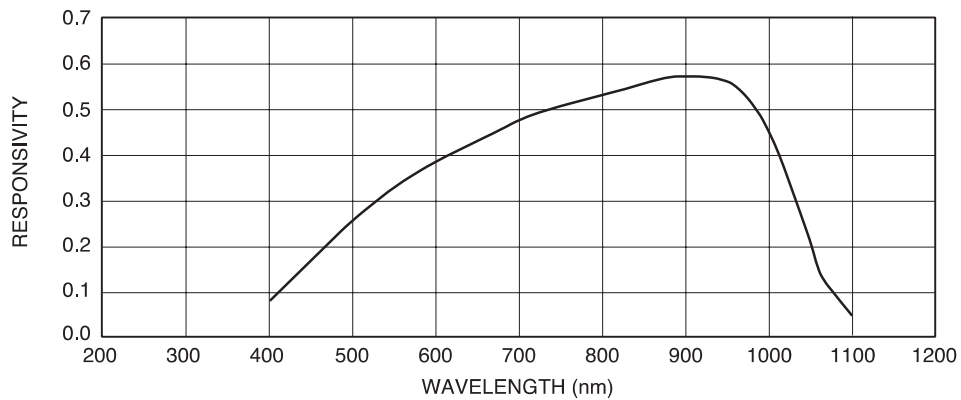

Dark Current vs Voltage

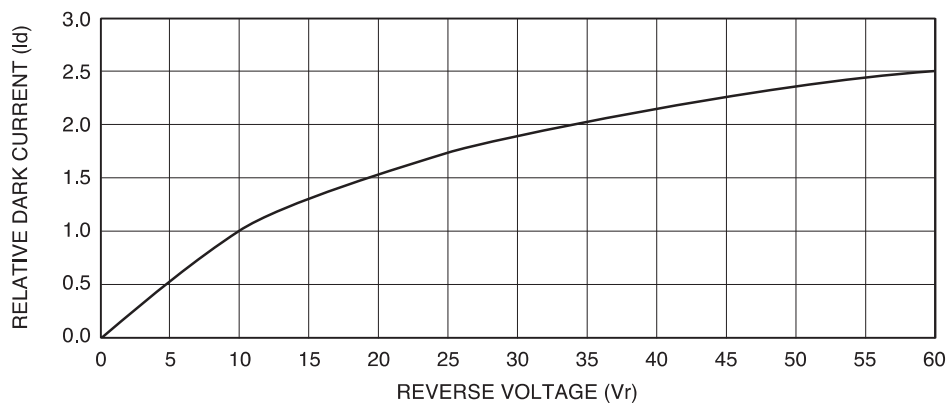

Package Information

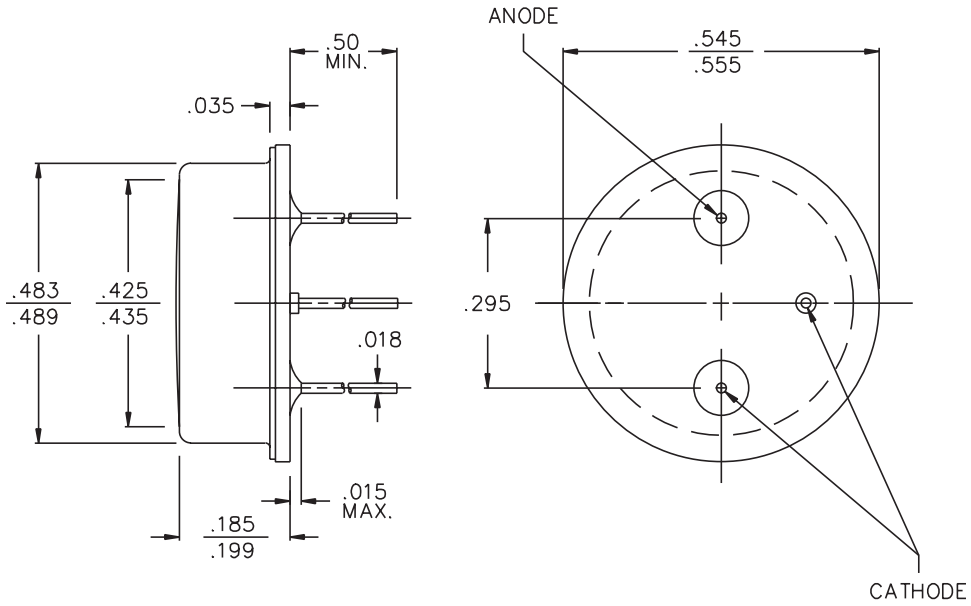

Dimensions are in inch [metric] units.

Specifications are subject to change without prior notice.